

WALL SYSTEMS

DEMOUNTABLE INTERNAL
METAL CLADDING

2020 series

INTERNAL COLUMN COVERING

An ideal solution for internal wall covering. Effective impact protection for high traffic areas. It's strong structure is suitable for integrated TV screens, sign boards & speakers. Progressive accessibility. Easy access for services & maintenance without any access tool. Offered in a wide range of designs, sizes, colors & finishes.

FEATURES

MATERIAL

Aluminum Alloy as per EN AW 3000 or 5000 series.

Zinc Plated Galvanized Steel G90 grade.

THICKNESS

Aluminum(mm): 1.0 to 3.0

Galvanized Steel (mm): 0.75 to 2.0

+ Custom thickness are available upon request

SURFACE FINISH

Plain

Perforated

SIZE

HEIGHT (mm): 300-750

LENGTH (mm):

RAM 2021, 2022, 2023:

≤ 3000 (Aluminum)

≤ 2000 (Galvanized Steel)

RAM 2024:

≤ 2000 (Galvanized Steel)

+ Custom sizes are available upon request

COATING

Polyester Powder Coating:
(70μ -80μ)

+ High Performance Coatings like PESDF, PVDF and POLYAMIDE are available upon request.

INSULATION

Acoustic Black Fleece is non-flammable and meets the standard DIN 4102 / B1. Classification A1 according to EN 13501-1.

Rockwool slabs conforming to ASTM C612 and equivalent BS 3958-5 are provided for acoustic insulation.

COLOR / FINISH

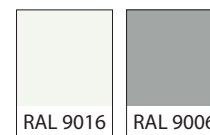
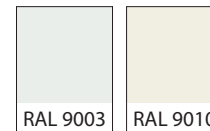

SPECIAL FINISHES

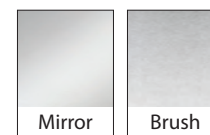
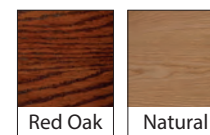

+ See www.rammetal.com for additional colors & special finishes available

+ Special finishes can be provided in lamination, sublimation or coil coating process.

PERFORATION PATTERNS

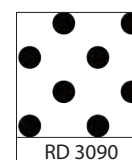
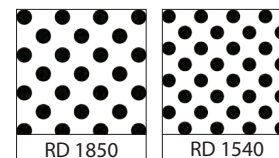

SURFACE PATTERNS

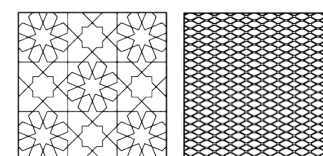

+ See www.rammetal.com for all other pattern options

DATA / PERFORMANCE



ACOUSTICS

Tested as per BS EN ISO 354: 2003 for sound absorption, noise reduction and sound attenuation.

Maximum NRC achieved with Acoustic Black fleece – NRC 0.75

Maximum NRC achieved with Acoustic Black Fleece and Rockwool Insulation – NRC 1.00



ANTI BACTERIAL COATING

Tested as per JIS Z 2801: 2000, which inhibits the growth of bacteria on the applied surface.



LIGHT REFLECTANCE (LR)

Achieved by the metal cladding is LR – 0.85-0.96 tested as per ASTM E 1477.



FIRE PERFORMANCE

Surface Spread of flame Class 1 tested as per BS 476: Part 7: 1997

“Non-Combustible” Material tested as per BS 476: Part4: 1970

Flame Spread and Smoke Development Index tested as per ASTM E84 (Class 1 or A) soft body impact test



SOFT BODY IMPACT TEST

Tested as per CWCT 75/76 - Impact performance of building envelopes.

Soft body test energy exposure category B

Serviceability - Class 1 (Impact energy 120 J)

Safety performance - Negligible risk (Impact energy 500 J)



ANTI DRUMMING

High performance sound deadening and reduced vibrations (resonance)

RAM 2021 SOLID PLAIN RAM 2022 PERFORATED RAM 2023 EXPANDED METAL MESH RAM 2024 ARCHITECTURAL FINISH

ISOMETRIC DETAIL

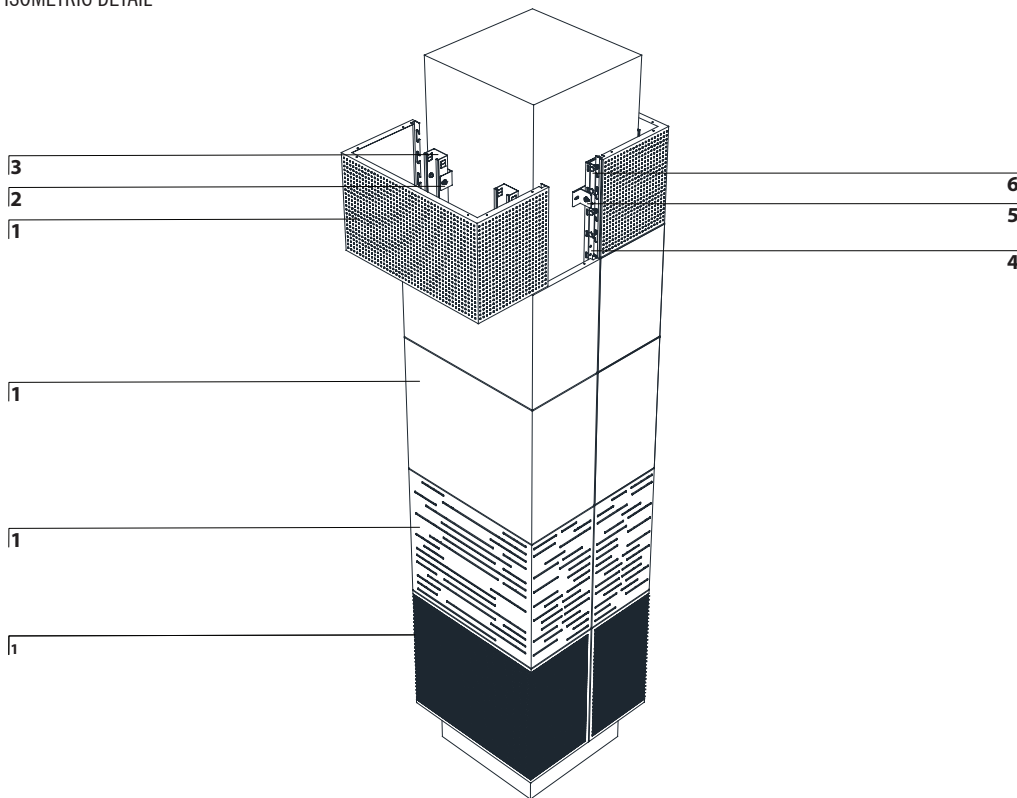

COMPONENTS

- 1 Panel
- 2 Reinforcement Bracket
- 3 Reinforcement Channel
- 4 Adjustable C Channel
- 5 Omega Profile
- 6 Carrier Bracket
- 7 Bolts & Nuts
- 8 Self-Adhesive Seal
- 9 Backing Board •
- 10 Backing Panel •
- 11 Rockwool •

SECTION DETAILS

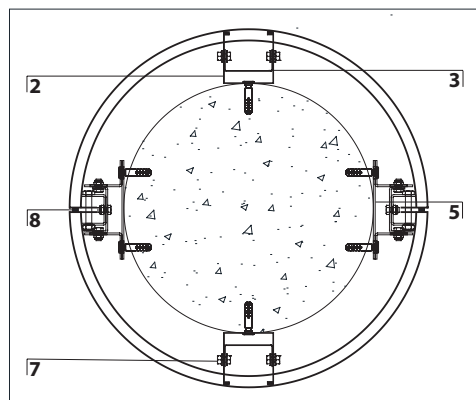
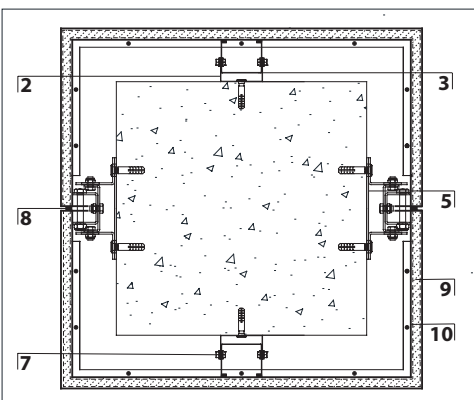

PANEL JOINTS DETAIL

